

# VANGUARD



# VANGUARD

The **Vanguard Series** of vapor-tight fixtures is ideal for industrial styled interior or exterior settings requiring extra protection, such as parking lots, walkways, and recreational, educational, institutional and health care applications. Suitable for use in wet locations, all models are fully gasketed to seal against moisture and exposure to the elements, including dust, fumes and insects. The Vanguard Series is available in pendant, ceiling and wall-mount configurations, with choice of incandescent, compact fluorescent lamping or H.I.D. lamping. Fixtures are supplied with clear tempered glass cylinders, protected by die-cast guards, with frosted or color diffusers also available by special order.

## ***About Luraline ..***

Since 1967, Luraline Products Company has built a reputation as a manufacturer of quality lighting fixtures. Our 30,000-square-foot, family-owned manufacturing facility and headquarters are located in South Florida. We pride ourselves on outstanding customer service and extraordinary attention to detail. Regardless of the size or scope of the project, you can depend on Luraline for all your lighting requirements.

## ***Our Products ...***

Our extensive catalog features interior and exterior lighting fixtures in pendant, ceiling, sconce, wall and post-mount configurations. We offer a full range of energy-saving options utilizing the latest technology in high-efficiency light sources, including compact fluorescent and H.I.D.

Luraline lighting fixtures are designed to fulfill a range of commercial applications, including, but not limited to, hospitality, restaurant, retail, entertainment, contract, educational, institutional, healthcare and multi-family and/or assisted living facilities. Fixtures are presented in coordinated groupings that ensure an attractive and cohesive lighting design for any installation.

In addition, Luraline also offers full custom design capabilities, with a CAD department that is available to produce fixtures of metal, plastic or wood construction, made to your specifications.

## ***Our Website ...***

Visit [www.luraline.com](http://www.luraline.com) to browse our full catalog, search for products, and submit Requests for Quote (RFQ).

Our website also features online Specification Submittal Sheets. To access this valuable tool, first perform a Search. Then, click on a chosen fixture to be taken to the Products page, where you can view and select among the available options for that item. After you have specified the details for your chosen fixture, enter the job name and fixture type onto the form. At the bottom of the form, choose Print Submittal Sheet. This results in a quality drawing, custom-tailored to the options and job that you have selected.



**VS Series - Vapor-Tight Surface Mount**

Standard surface mount fittings accept 1/2" conduit. For 3/4" conduit, add suffix "-3/4" to catalog number.

· Fixtures are fully gasketed and suitable for wet locations or outdoor environments that require extra protection.

**VS200**

Incandescent lamping: Accepts one 200W Maximum A21 lamp.

Fluorescent lamping: (-13Q) Includes one 13W CF lamp with 120V/NPF magnetic ballast, housed in extended body (adds 2-1/2" to H).

H.I.D. lamping: Includes one 50W High Pressure Sodium (-H50/R) or Metal Halide (-M50/R) medium-base lamp with remote-mounted (/R) dual-tap 120/277 Volt/HPF magnetic ballast.

**Please ADD desired Light Source code to catalog number when ordering.**

Example: **VS200**

(Incandescent -no Light Source code required)

See Page VG-8 for Optional Accessories.

**VS200**  
(Incandescent/H.I.D.)  
4-1/2" W, 9-7/8" H



**VS200**  
(Fluorescent)  
4-1/2" W, 12-3/8" H

**VS300**

Incandescent lamping: Accepts one 300W Maximum PS25 lamp.

Fluorescent lamping: (-13Q) includes one 13W or 22W (-22Q) CF lamp with 120V/NPF magnetic ballast, housed in extended body (adds 2-1/2" to H).

H.I.D. lamping: Includes one 50W, 70W or 100W High Pressure Sodium (-H50/R, -H70/R, -H100/R) or Metal Halide (-M50/R, -M70/R, -M100/R) medium-base lamp with remote-mounted (/R) dual-tap 120/277 Volt/HPF magnetic ballast.

**Please ADD desired Light Source code to catalog number when ordering.**

Example: **VS300-22Q**

See Page VG-8 for Optional Accessories.

**VS300**  
(Incandescent/H.I.D.)  
5-5/8" W, 11-5/8" H



**VS300**  
(Fluorescent)  
5-5/8" W, 14-1/8" H

**VPS Series – Vapor-Tight Stem Mount**

Provided with 24" long, 1/2" conduit stem and hang-straight swivel canopy, designed for installation over a recessed 4" octagon box.

- Despite their small size, Vanguard fixtures accommodate unusually high incandescent wattage ratings, with 200W and 300W maximums.

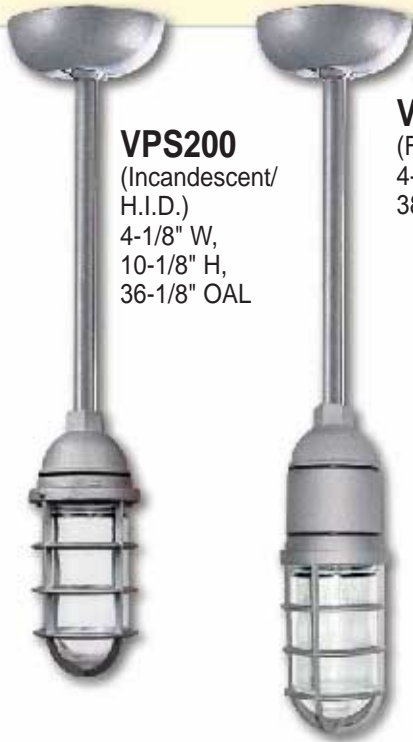

**VPS200**  
(Incandescent/  
H.I.D.)  
4-1/8" W,  
10-1/8" H,  
36-1/8" OAL

**VPS200**  
(Fluorescent)  
4-1/8" W, 12-5/8" H,  
38-5/8" OAL

**VPS200**

Incandescent lampping: Accepts one 200W Maximum A21 lamp.

Fluorescent lampping: (-13Q) Includes one 13W CF lamp with 120V/NPF magnetic ballast, housed in extended body (adds 2-1/2" to H).

H.I.D. lampping: Includes one 50W High Pressure Sodium (-H50/R) or Metal Halide (-M50/R) medium-base lamp with remote-mounted (R) dual-tap 120/277 Volt/HPF magnetic ballast.

**Please ADD desired Light Source code to catalog number when ordering.**

Example: **VPS200-13Q**

See Page VG-8 for Optional Accessories.



**VPS300**  
(Incandescent/  
H.I.D.)  
5-5/8" W, 12" H,  
38" OAL

**VPS300**  
(Fluorescent)  
5-5/8" W, 14-1/2" H,  
40-1/2" OAL

**VPS300**

Incandescent lampping: Accepts one 300W Maximum PS25 lamp.

Fluorescent lampping: (-13Q) Includes one 13W or 22W (-22Q) CF lamp with 120V/NPF magnetic ballast, housed in extended body (adds 2-1/2" to H).

H.I.D. lampping: Includes one 50W, 70W or 100W High Pressure Sodium (-H50/R, -H70/R, -H100/R) or Metal Halide (-M50/R, -M70/R, -M100/R) medium-base lamp with remote-mounted (R) dual-tap 120/277 Volt/HPF magnetic ballast.

**Please ADD desired Light Source code to catalog number when ordering.**

Example: **VPS300-H50/R**

See Page VG-8 for Optional Accessories.

**VPA Series – Vapor-Tight Arm Mount**

Provided with 23" x 3/4" conduit arm and cast-aluminum canopy.

•Add the optional angled reflector for optimum wall wash in signage applications, or choose the decorative yet functional RLM reflector.

**VPA200**

(Incandescent/H.I.D.)  
4-1/8" W, 18-1/2" H,  
24-5/8" E, 8-1/4" Mtg.Ctr.

**VPA200**

Incandescent lamping: Accepts one 200W Maximum A21 lamp.

Fluorescent lamping: (-13Q) Includes one 13W CF lamp with 120V/NPF magnetic ballast, housed in extended body (adds 2-1/2" to H).

H.I.D. lamping: Includes one 50W High Pressure Sodium (-H50/R) or Metal Halide (-M50/R) medium-base lamp with remote-mounted (R) dual-tap 120/277 Volt/HPF magnetic ballast.

**Please ADD desired Light Source code to catalog number when ordering.**

Example: **VPA200-13Q**

See Page VG-8 for Optional Accessories.



**VPA200**

(Fluorescent)  
4-1/8" W, 21" H,  
24-5/8" E, 8-1/4" Mtg.Ctr.

**VPA300**

(Incandescent/H.I.D.)  
5-5/8" W, 20-1/4" H,  
25-1/2" E, 8-1/4" Mtg.Ctr.

**VPA300**

Incandescent lamping: Accepts one 300W Maximum PS25 lamp.

Fluorescent lamping: (-13Q) Includes one 13W or 22W (-22Q) CF lamp with 120V/NPF magnetic ballast, housed in extended body (adds 2-1/2" to H).

H.I.D. lamping: Includes one 50W, 70W or 100W High Pressure Sodium (-H50/R, -H70/R, -H100/R) or Metal Halide (-M50/R, -M70/R, -M100/R) medium-base lamp with remote-mounted (R) dual-tap 120/277 Volt/HPF magnetic ballast.

**Please ADD desired Light Source code to catalog number when ordering.**

Example: **VPA300-M100/R**

See Page VG-8 for Optional Accessories.

**VPA300**

(Fluorescent)  
5-5/8" W, 22-3/4" H,  
25-1/2" E, 8-1/4" Mtg.Ctr.





**VS300**  
(shown with VSR300)

**VPS200**  
(shown with VAR200)

**VPS200**  
(shown with VSR200)

**VPS300**  
(shown with VAR300)

See Page VG-8 for Optional Accessories



**VS300**  
(shown with VAR300)

**VPA300**  
(shown with VAR300)

**VPA200**  
(shown with VSR200)

**VPA200**  
(shown with VAR200  
and VWGA)

**VPA200**  
(shown with VSR200  
and VWGS)

See Page VG-8 for Optional Accessories

VANGUARD

**VW Series - Vapor-Tight Wall Mount**

Standard surface mount fittings accept 1/2" conduit. For 3/4" Conduit, add suffix "-3/4" to catalog number.

- Wall mount fixtures are ideal for installation along corridors and walkways or on exterior building facades.



**VW200**

(Incandescent/ H.I.D.)  
 4-1/2" W, 12-1/2" H,  
 6-7/8" E, 2-1/2" Mtg.Ctr.

**VW200**

Incandescent lamping: Accepts one 200W Maximum A21 lamp.

Fluorescent lamping: (-13Q) Includes one 13W CF lamp with 120V/NPF magnetic ballast, housed in extended body (adds 2-1/2" to H).

H.I.D. lamping: Includes one 50W High Pressure Sodium (-H50/R) or Metal Halide (-M50/R) medium-base lamp with remote-mounted (/R) dual-tap 120/277 Volt/HPF magnetic ballast.

**Please ADD desired Light Source code to catalog number when ordering.**

Example: **VW200-13Q**

See Page VG-8 for Optional Accessories.

**VW200**

(Fluorescent)  
 4-1/2" W, 15" H,  
 6-7/8" E, 2-1/2" Mtg.Ctr.



**VW300**

(Incandescent/H.I.D.)  
 5-5/8" W, 14-3/8" H,  
 7-3/8" E, 2-1/2" Mtg.Ctr.

**VW300**

Incandescent lamping: Accepts one 300W Maximum PS25 lamp.

Fluorescent lamping: (-13Q) Includes one 13W or 22W (-22Q) CF lamp with 120V/NPF magnetic ballast, housed in extended body (adds 2-1/2" to H).

H.I.D. lamping: Includes one 50W, 70W or 100W High Pressure Sodium (-H50/R, -H70/R, -H100/R) or Metal Halide (-M50/R, -M70/R, -M100/R) medium-base lamp with remote-mounted (/R) dual-tap 120/277 Volt/HPF magnetic ballast.

**Please ADD desired Light Source code to catalog number when ordering.**

Example: **VW300-M70/R**

See Page VG-8 for Optional Accessories.

**VW300**

(Fluorescent)  
 5-5/8" W, 16-7/8" H,  
 7-3/8" E, 2-1/2" Mtg.Ctr.

**VPH Series - Vapor-Tight Pendant Heads**

Fixture heads only, for use with conduit stems. Arms and canopies **supplied by others**.  
 Standard fittings accept 1/2" conduit. For 3/4" conduit, add suffix "-3/4" to catalog number.

**VPH200**

Incandescent lamping: Accepts one 200W Maximum A21 lamp.

Fluorescent lamping: (-13Q) Includes one 13W CF lamp with 120V/NPF magnetic ballast, housed in extended body (adds 2-1/2" to H).

H.I.D. lamping: Includes one 50W High Pressure Sodium (-H50/R) or Metal Halide (-M50/R) medium-base lamp with remote-mounted (R) dual-tap 120/277 Volt/HPF magnetic ballast.

**Please ADD desired Light Source code to catalog number when ordering.**

Example: **VPH200**

(Incandescent -no Light Source code required)

See Page VG-8 for Optional Accessories.

**VPH200**  
 (Incandescent/H.I.D.)  
 4-1/8" W, 10-1/8" H



**VPH200**  
 (Fluorescent)  
 4-1/8" W, 12-5/8" H

**VPH300**

Incandescent lamping: Accepts one 300W Maximum PS25 lamp.

Fluorescent lamping: (-13Q) Includes one 13W or 22W (-22Q) CF lamp with 120V/NPF magnetic ballast, housed in extended body (adds 2-1/2" to H).

H.I.D. lamping: Includes one 50W, 70W or 100W High Pressure Sodium (-H50/R, -H70/R, -H100/R) or Metal Halide (-M50/R, -M70/R, -M100/R) medium-base lamp with remote-mounted (R) dual-tap 120/277 Volt/HPF magnetic ballast.

**Please ADD desired Light Source code to catalog number when ordering.**

Example: **VPH300-22Q**

See Page VG-8 for Optional Accessories.

**VPH300**  
 (Incandescent/H.I.D.)  
 5-5/8" W, 12" H



**VPH300**  
 (Fluorescent)  
 5-5/8" W, 14-1/2" H

**VANGUARD OPTIONAL ACCESSORIES**

Optional accessories for **Vanguard** industrial lighting fixtures include a decorative yet functional aluminum RLM reflector, and an angled reflector for optimum wall wash in signage applications. The clear tempered glass diffuser is also available frosted or tinted for added visual interest, or choose a stainless steel wire guard for added protection.

**REFLECTORS**



**VAR200/VAR300**

**VAR200** - 12" Dia. aluminum angle reflector for use with VP200 and VS200 models.  
**VAR300** - 12" Dia. aluminum angle reflector for use with VP300 and VS300 models.



**VSR200/VSR300**

**VSR200** - 16" Dia. aluminum straight reflector for use with VP200 and VS200 models.  
**VSR300** - 16" Dia. aluminum straight reflector for use with VP300 and VS300 models

**WIRE GUARDS**  
Used in lieu of cast guards.



**VWGA**

Attaches to VAR200 spun aluminum angle reflector for use with VP200 and VS200 models.



**VWGS**

Attaches to VSR200 spun aluminum straight reflector for use with VP200 and VS200 models.

Note: VWGA and VWGS may be used with VP300 and VS300 models, in **indoor applications only**, without glass and guard.

**DIFFUSERS**

For optional COLORED glass diffusers, please add appropriate suffix to catalog number when ordering.  
 Example: **VS200 FR**



Frosted (FR)



Tinted Yellow (TY)



Tinted Green (TG)



Tinted Red (TR)



Tinted Blue (TB)

PLEASE NOTE: Use of tinted diffusers reduces maximum wattage rating to 100W on 200W models and to 200W on 300W models.

# VANGUARD

## APPLICATIONS:

Uses include industrial styled interiors in retail, restaurant and hospitality settings, as well as loading docks, elevator pits, waterfronts or outdoor environments requiring extra protection, such as parking lots; exterior walkways; recreational areas; and educational, commercial, institutional and health care facilities; among others.

## CONSTRUCTION:

Housings and guards constructed of die-cast aluminum. Silicone gasket protects against dust, moisture and insects. VPS stem mount models are designed for installation over a recessed 4" octagon box. All other models accept 1/2" surface conduit, with 3/4" conduit models also available by special order. Wire guards, spun-aluminum RLM and angle reflectors are optional accessories.

## DIFFUSERS:

All models are supplied with clear threaded borosilicate tempered glass diffuser. The following colors may be special ordered (minimum order quantities apply): Frosted (**FR**), Tinted Blue (**TB**), Tinted Green (**TG**), Tinted Red (**TR**) or Tinted Yellow (**TY**) glass.

## LAMP HOLDERS:

Incandescent models supplied with medium-base porcelain socket with nickel-plated screw shell and center contact. Compact Fluorescent models supplied with heat-resistant thermoplastic socket with lamp retention clips, providing for secure lamp fit and easy push-pull re-lamping. H.I.D. models supplied with 4KV pulse-rated medium-base porcelain with brass nickel-plated screw shell and center contact, reinforced with corrosion-resistant leaf spring.

## BALLASTS:

**Compact Fluorescent** - Electro-magnetic 120-Volt Normal Power Factor indoor/outdoor Type 1 ballast. 13W models rated for 32° F start, 22W models rated for -20° F start.

**H.I.D** - High Pressure Sodium and Metal Halide models are supplied with remote-mounted, dual-tap (120/277) 60Hz, High Power Factor, indoor/outdoor type 1, encased and potted ballast. Starting temperature rated at -20° F.

Note: maximum lamp-to-ballast distance of 10 feet for High Pressure Sodium models, 20 feet for Metal Halide models. Weather-tight enclosure (by others) required for installation in wet locations.

## FINISHES:

Cast housings, guards and optional reflectors are supplied with thermosetting polyester (TGIC) textured aluminum powder coat finish. Non-standard, custom colors and color matching (with submission of color chip) are supplied with industrial-grade exterior enamel liquid coating and are not returnable. Set-up charge required.

## COMPLIANCE:

NRTL Certified. Suitable for wet, damp or dry locations.

# VANGUARD



**LURALINE PRODUCTS CO.** A Division of Exciting Products Manufacturing Corp.  
Telephone: 305.685.6588 · 800.940.6588 · Facsimile: 305.685.6500